

Curvas de cargas - Load diagrams - Lastkurven - Courbes de charges - Curve di carico - График грузоподъёмности

60 m

| | | | | | | | | | | | | | | | | | | |
|------|------|------|------|------|------|------|------|------|------|------|------|------|------|------|------|------|------|----|
| 24 | 25 | 26 | 28 | 30 | 31,8 | 33 | 35 | 37 | 39 | 40 | 43 | 45 | 48 | 50 | 52 | 55 | 60 | m |
| 3000 | 3000 | 3000 | 3000 | 3000 | 3000 | 2868 | 2640 | 2484 | 2323 | 2230 | 2048 | 1929 | 1770 | 1676 | 1589 | 1470 | 1300 | Kg |
| 15 | 16 | 18 | 21 | 24 | 27 | 31,3 | 33 | 35 | 38 | 40 | 43 | 45 | 48 | 50 | 52 | 55 | 60 | m |
| 3000 | 3000 | 3000 | 3000 | 3000 | 3000 | 3000 | 2755 | 2580 | 2292 | 2160 | 1941 | 1840 | 1667 | 1580 | 1486 | 1370 | 1200 | Kg |
| 15 | 16 | 17,6 | 20 | 25 | 27 | 30 | 33 | 35 | 38 | 40 | 43 | 45 | 48 | 50 | 52 | 55 | 60 | m |
| 6000 | 6000 | 6000 | 5190 | 3950 | 3554 | 3140 | 2755 | 2580 | 2292 | 2160 | 1941 | 1840 | 1667 | 1580 | 1486 | 1370 | 1200 | Kg |
| 15 | 16 | 18 | 18,7 | 24 | 27 | 30 | 33 | 35 | 38 | 40 | 43 | 45 | 48 | 50 | 52 | 55 | 60 | m |
| 6000 | 6000 | 6000 | 6000 | 4431 | 3832 | 3360 | 2979 | 2764 | 2485 | 2324 | 2111 | 1985 | 1818 | 1718 | 1625 | 1500 | 1320 | Kg |

55 m

| | | | | | | | | | | | | | | | | | |
|------|------|------|------|------|------|------|------|------|------|------|------|------|------|------|------|------|----|
| 24 | 25 | 26 | 28 | 30 | 33 | 35 | 35,9 | 37 | 39 | 40 | 43 | 45 | 48 | 50 | 52 | 55 | m |
| 3000 | 3000 | 3000 | 3000 | 3000 | 3000 | 3000 | 3000 | 2907 | 2723 | 2638 | 2409 | 2274 | 2093 | 1985 | 1885 | 1750 | Kg |
| 15 | 16 | 18 | 21 | 24 | 30 | 33 | 35 | 35,2 | 38 | 40 | 43 | 45 | 48 | 50 | 52 | 55 | m |
| 3000 | 3000 | 3000 | 3000 | 3000 | 3000 | 3000 | 3000 | 3000 | 2705 | 2540 | 2304 | 2180 | 1990 | 1890 | 1784 | 1650 | Kg |
| 15 | 16 | 19,9 | 21 | 25 | 27 | 30 | 33 | 35 | 38 | 40 | 43 | 45 | 48 | 50 | 52 | 55 | m |
| 6000 | 6000 | 6000 | 5634 | 4580 | 4149 | 3660 | 3235 | 3020 | 2705 | 2540 | 2304 | 2180 | 1990 | 1890 | 1784 | 1650 | Kg |
| 15 | 16 | 18 | 21,2 | 24 | 27 | 30 | 33 | 35 | 38 | 40 | 43 | 45 | 48 | 50 | 52 | 55 | m |
| 6000 | 6000 | 6000 | 6000 | 5187 | 4497 | 3955 | 3517 | 3269 | 2948 | 2762 | 2518 | 2373 | 2180 | 2065 | 1959 | 1815 | Kg |

50 m

| | | | | | | | | | | | | | | | |
|------|------|------|------|------|------|------|------|------|------|------|------|------|------|------|----|
| 24 | 25 | 26 | 28 | 30 | 33 | 35 | 37 | 39 | 39,7 | 40 | 43 | 45 | 48 | 50 | m |
| 3000 | 3000 | 3000 | 3000 | 3000 | 3000 | 3000 | 3000 | 3000 | 3000 | 2960 | 2719 | 2570 | 2369 | 2250 | Kg |
| 15 | 18 | 21 | 24 | 27 | 33 | 35 | 38 | 38,7 | 40 | 43 | 45 | 48 | 50 | m | |
| 3000 | 3000 | 3000 | 3000 | 3000 | 3000 | 3000 | 3000 | 3000 | 2880 | 2617 | 2470 | 2269 | 2150 | Kg | |
| 15 | 21 | 21,8 | 25 | 27 | 30 | 33 | 35 | 38 | 40 | 43 | 45 | 48 | 50 | m | |
| 6000 | 6000 | 6000 | 5120 | 4659 | 4110 | 3648 | 3400 | 3061 | 2880 | 2617 | 2470 | 2269 | 2150 | Kg | |
| 15 | 18 | 19 | 21 | 23,4 | 27 | 30 | 33 | 35 | 38 | 40 | 43 | 45 | 48 | m | |
| 6000 | 6000 | 6000 | 6000 | 6000 | 5071 | 4467 | 3980 | 3704 | 3347 | 3141 | 2868 | 2708 | 2493 | Kg | |

45 m

| | | | | | | | | | | | | | |
|------|------|------|------|------|------|------|------|------|------|------|------|------|----|
| 24 | 25 | 26 | 28 | 30 | 33 | 35 | 37 | 38 | 39 | 40 | 41,9 | 45 | m |
| 3000 | 3000 | 3000 | 3000 | 3000 | 3000 | 3000 | 3000 | 3000 | 3000 | 3000 | 3000 | 2750 | Kg |
| 15 | 18 | 20 | 21 | 24 | 27 | 30 | 33 | 35 | 37 | 40,8 | 43 | 45 | m |
| 3000 | 3000 | 3000 | 3000 | 3000 | 3000 | 3000 | 3000 | 3000 | 3000 | 3000 | 2808 | 2650 | Kg |
| 15 | 18 | 20 | 21 | 23,1 | 25 | 30 | 33 | 35 | 37 | 40 | 43 | 45 | m |
| 6000 | 6000 | 6000 | 6000 | 6000 | 5450 | 4380 | 3900 | 3630 | 3388 | 3080 | 2808 | 2650 | Kg |
| 15 | 16 | 20 | 21 | 24,8 | 27 | 30 | 33 | 35 | 38 | 40 | 43 | 45 | m |
| 6000 | 6000 | 6000 | 6000 | 6000 | 5426 | 4785 | 4267 | 3973 | 3594 | 3375 | 3085 | 2915 | Kg |

40 m





| | | | | | | | | | | | |
|------|------|------|------|------|------|------|------|------|------|------|----|
| 24 | 25 | 26 | 28 | 30 | 34 | 35 | 37 | 38 | 39 | 40 | m |
| 3000 | 3000 | 3000 | 3000 | 3000 | 3000 | 3000 | 3000 | 3000 | 3000 | 3000 | Kg |
| 15 | 18 | 20 | 22 | 24 | 27 | 30 | 34 | 36 | 38 | 40 | m |
| 3000 | 3000 | 3000 | 3000 | 3000 | 3000 | 3000 | 3000 | 3000 | 3000 | 3000 | Kg |
| 15 | 18 | 20 | 22 | 23,5 | 25 | 30 | 33 | 35 | 38 | 40 | m |
| 6000 | 6000 | 6000 | 6000 | 6000 | 5570 | 4480 | 3991 | 3720 | 3357 | 3150 | Kg |
| 15 | 16 | 20 | 21 | 25,3 | 27 | 30 | 33 | 35 | 38 | 40 | m |
| 6000 | 6000 | 6000 | 6000 | 6000 | 5563 | 4907 | 4377 | 4077 | 3689 | 3465 | Kg |

35 m 

| | | | | | | | |
|------|------|------|------|------|------|------|---|
| 24 | 25 | 26 | 28 | 30 | 35 | m |  |
| 3000 | 3000 | 3000 | 3000 | 3000 | 3000 | Kg | |
| 15 | 19 | 20 | 21 | 24 | 27 | 33 | 35 |
| 3000 | 3000 | 3000 | 3000 | 3000 | 3000 | 3000 | 3000 |
| 15 | 18 | 19 | 21 | 23,4 | 25 | 30 | 35 |
| 6000 | 6000 | 6000 | 6000 | 6000 | 5550 | 4463 | 3700 |
| 15 | 16 | 19 | 21 | 25,3 | 27 | 30 | 35 |
| 6000 | 6000 | 6000 | 6000 | 6000 | 5553 | 4898 | 4070 |





SL 

30 m 

| | | | | | | |
|------|------|------|---|------|----|---|
| 15 | 30 | m |  | | | |
| 3000 | 3000 | Kg | | | | |
| 15 | 30 | m |  | | | |
| 3000 | 3000 | Kg |  | | | |
| 10 | 15 | 20 | 23,6 | 30 | m |  |
| 6000 | 6000 | 6000 | 6000 | 4500 | Kg | |
| 15 | 16 | 20 | 25,5 | 30 | m |  |
| 6000 | 6000 | 6000 | 6000 | 4950 | Kg | |





SL 

25 m 

| | | | | | | |
|------|------|------|---|------|----|---|
| 15 | 25 | m |  | | | |
| 3000 | 3000 | Kg | | | | |
| 15 | 25 | m |  | | | |
| 3000 | 3000 | Kg |  | | | |
| 10 | 15 | 20 | 23,2 | 25 | m |  |
| 6000 | 6000 | 6000 | 6000 | 5500 | Kg | |
| 15 | 16 | 20 | 21 | 25 | m |  |
| 6000 | 6000 | 6000 | 6000 | 6000 | Kg | |

SL 

20 m 

| | | | | | | |
|------|------|------|---|------|----|--|
| 15 | 20 | m |  | | | |
| 3000 | 3000 | Kg | | | | |
| 15 | 20 | m |  | | | |
| 3000 | 3000 | Kg |  | | | |
| 10 | 15 | 17 | 18 | 20 | m |  |
| 6000 | 6000 | 6000 | 6000 | 6000 | Kg | |
| 15 | 16 | 18 | 21 | 20 | m |  |
| 6000 | 6000 | 6000 | 6000 | 6000 | Kg | |

SL 

 Consultarnos - Consultateci - Consult us - Nous consulter - Auf anfrage - советываться

SL-SUPERLIFT Otras velocidades y características de funcionamiento – Variant speeds and service conditions – Abweichende Geschwindigkeiten und Betriebsbedingungen – Vitesses et conditions de fonctionnement différentes – Differenti velocità e condizioni di funzionamento – Нестандартные скорости и условия эксплуатации

Bloque de contrapeso - Counterweight blocks - Gegengewichtsblöcke - Bloc de contrepoid - Blocco di contrappeso - Плиты противовеса





|  | 60 m | | | 55 m | | | 50 m | | | 45 m | | | 40 m | | |
|---|----------|---|---|----------|---|---|----------|---|---|----------|---|---|----------|---|---|
| | A | B | C | A | B | C | A | B | C | A | B | C | A | B | C |
| | 5 | 2 | - | 5 | 2 | - | 5 | 2 | - | 5 | 1 | - | 4 | 2 | - |
| | 16750 Kg | | | 16750 Kg | | | 16750 Kg | | | 15250 Kg | | | 14000 Kg | | |



|  | 35 m | | | 30 m | | | 25 m | | | 20 m | | |
|---|----------|---|---|----------|---|---|---------|---|---|---------|---|---|
| | A | B | C | A | B | C | A | B | C | A | B | C |
| | 4 | 1 | - | 3 | 2 | - | 3 | 1 | - | 2 | 2 | - |
| | 12500 Kg | | | 11250 Kg | | | 9750 Kg | | | 8500 Kg | | |

Mecanismos - Mechanisms - Antriebe - Mécanismes - Meccanismi - Приводы



33 Hp (24 Kw) INV
400V / 50HZ

HBG D-Max 190m S/R Ø10mm

|  |  | m/min |  | | | |  | | | |
|---|---|-------|---|------|------|-------|---|--------|------|------|
| | | | 0-8 | 0-35 | 0-56 | 0-100 | 0-4 | 0-17,5 | 0-28 | 0-50 |
| 380 m | | Kg | 3000 | 3000 | 2200 | 1000 | 6000 | 6000 | 4400 | 2000 |
| | | Kw | 24 | 24 | 24 | 24 | 24 | 24 | 24 | 24 |

| | | | | |
|---|-------|--------------|-----|-----|
|  | m/min | 11 / 37 / 75 | | |
| | Kw | 3 | | |
|  | r.p.m | 0,3 | 0,6 | 0,9 |
| | Kw | 2 x 5,5 | | |
|  | m/min | 20 | | |
| | Kw | 2 x 2,2 | | |

33Hp (24Kw) - INV

|  |  | 400V 50Hz I _{max} = 72A Fuse= 80A | TOTAL POWER 42 KVA | GENERATOR 75 KVA | 100m | 150m | 200m |
|---|---|---|-----------------------|---------------------|------|------|---------------------|
| 2000/14/CEE 2005/68/CEE | 2006/95 /CEE | * 480V 60Hz I _{max} = 60A Fuse = 70A | | | | | 4x25mm ² |

* Opcional / Optional / Opzionale

 Elevación / Hoisting / Heben / Levage / Sollevamento

 Distribución / Trolleying / Katzfahren / Distribution / Distribuzione

 Orientación / Slewing / Schwenken / Orientation / Rotazione

 Traslación / Travelling / Schienenfahren / Translation / Traslazione

 Cable / Rope / Seil / Câble / Funè

FEM 1005-C25 / EN 14439 - Mástil (S12) / Reacciones - Masts / Reactions - Mast / Eckdrücke - Mat / Réactions - Torre / Réazioni - Реакции / Комплектация башни

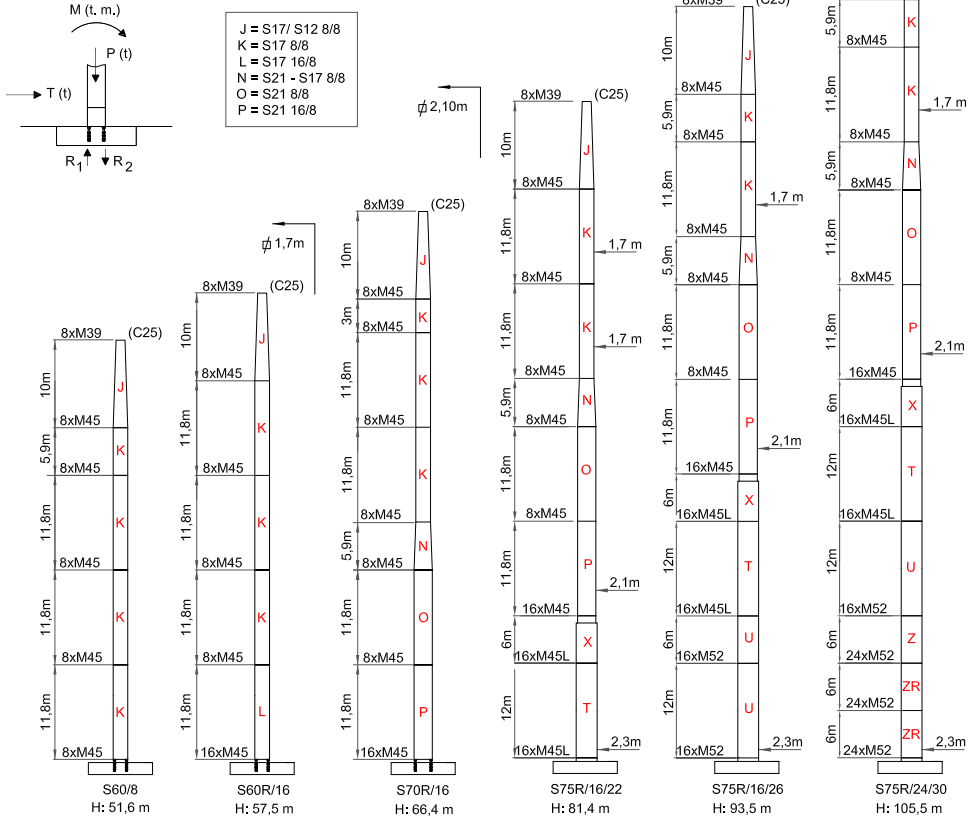

| | | | | | | | | | |
|-----|---------|-------|-------|-------|-------|-------|-------|--------|--------|
| C25 | H (m) | 22,1 | 39,9 | 51,6 | 57,5 | 66,4 | 81,4 | 93,5 | 105,5 |
| | M (T·m) | 142,6 | 252,8 | 385,6 | 484,8 | 640,5 | 981,6 | 1328,6 | 1738,4 |
| | T (t) | 4,5 | 6,4 | 11,5 | 12,7 | 14,5 | 18,8 | 23,3 | 27,3 |
| | P (t) | 41,9 | 50,3 | 55,9 | 58,8 | 63,7 | 75,3 | 91,4 | 104,1 |

FEM 1005-C25 / EN 14439 - Mástil (S17) / Reacciones - Masts / Reactions - Maste / Eckdrücke - Mat / Réactions - Torre / Réazioni - Реакции / Комплектация башни

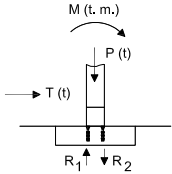

K = S17 8/8
L = S17 16/8
N = S21 - S17 8/8
O = S21 8/8
P = S21 16/8

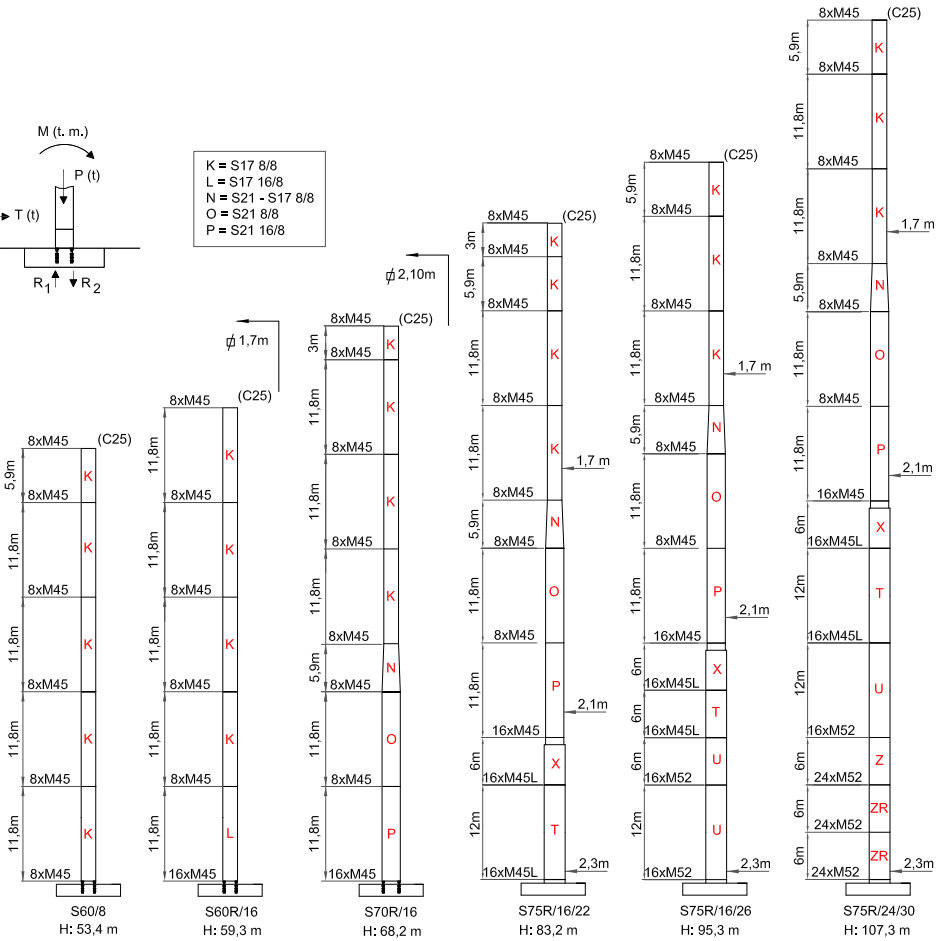

| C25 | H (m) | 23,95 | 38,7 | 53,45 | 59,35 | 68,25 | 83,25 | 95,3 | 107,35 |
|--------|---------|-------|-------|-------|-------|-------|-------|--------|--------|
| | M (T·m) | 142,6 | 230,9 | 385,6 | 484,8 | 640,5 | 981,6 | 1328,6 | 1738,4 |
| T (kN) | 4,55 | 6,16 | 11,53 | 12,7 | 14,59 | 18,84 | 23,34 | 27,39 | 33,15 |
| P (kN) | 41,9 | 48,9 | 55,9 | 58,8 | 63,7 | 75,3 | 91,45 | 104,15 | 121,15 |

FEM 1005-C25 / EN 14439 - Bloque lastre de base (S12) - Base ballast block - Grundballastblöcke - Bloc de lest de base - Blocco di zavorra alla base - Балласты опорной рамы

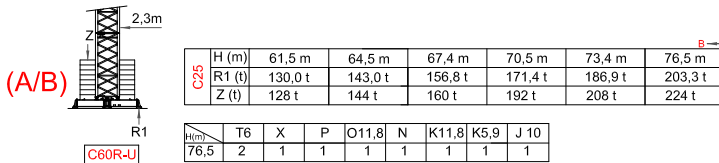
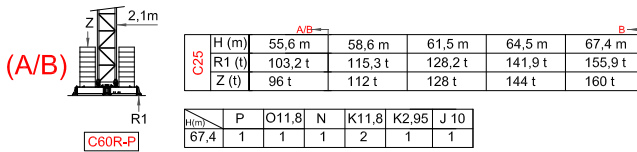
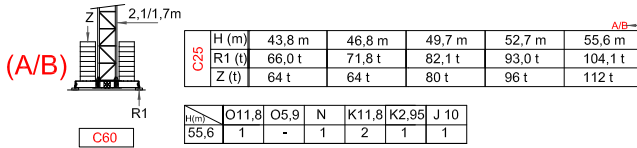
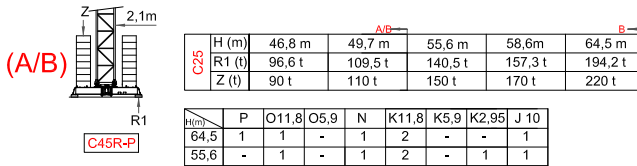
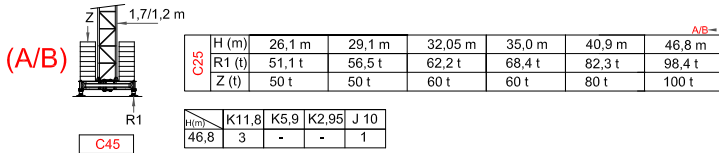
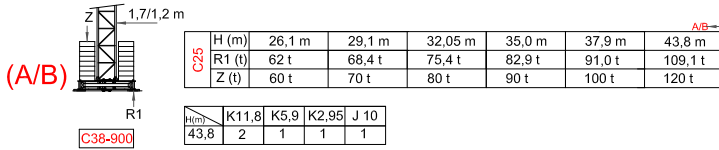

FEM 1005-C25 / EN 14439 - Bloque lastre de base (S17) - Base ballast block - Grundballastblöcke - Bloc de lest de base - Blocco di zavorra alla base - Балласты опорной рамы

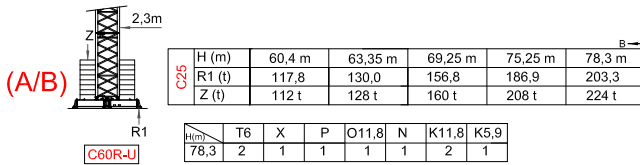
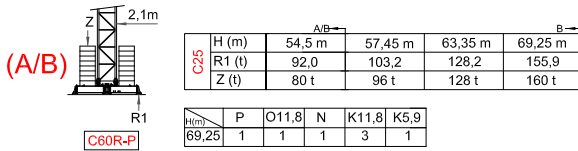
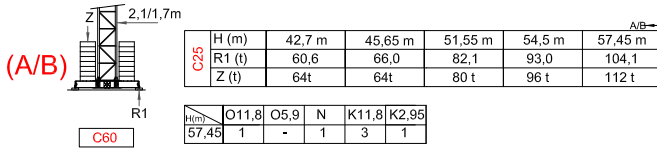
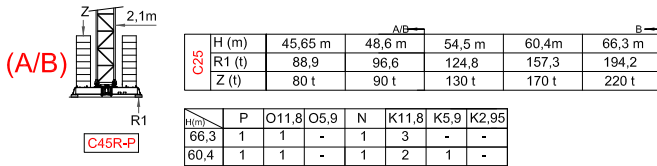
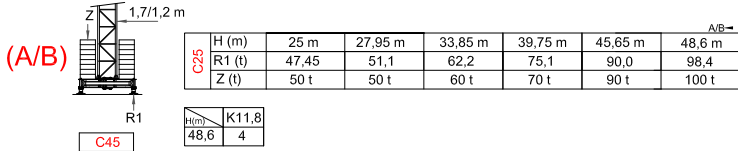
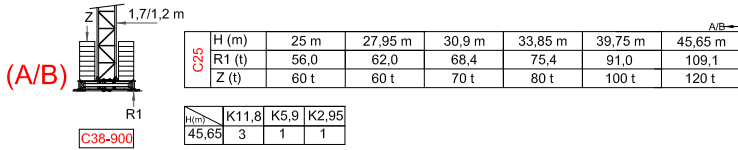

Proceso de trepado (S12) - Climbing - Kletterkrane - Telescopable - Sopralzo idraulico - Процесс наращивания крана

C25 TREPADO EXTERNO / EXTERNAL CLIMBING / GEANKERTER KRAN / GRUE ANDRÉE / GRU ANCORATA / ВОСХОЖДЕНИЕ ЭКСТЕРНО

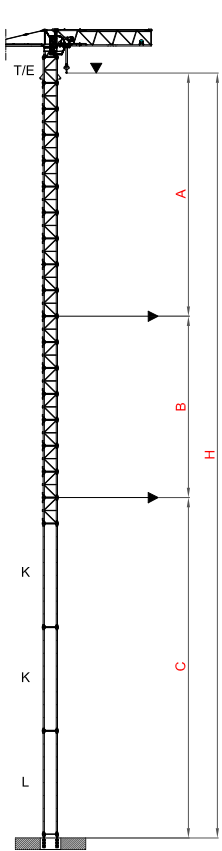

| | MONOBLOCK K/2,95m |
|-------------------|-------------------|
| A max. | 30,6 m |
| B max. | 20,6 m |
| C max. | 44,5 m |
| Hl max. | 52,3 m |
| H max. C+B+A | 95,7 m |
| H max. C+B+B+A | 116,3 m / (1) |

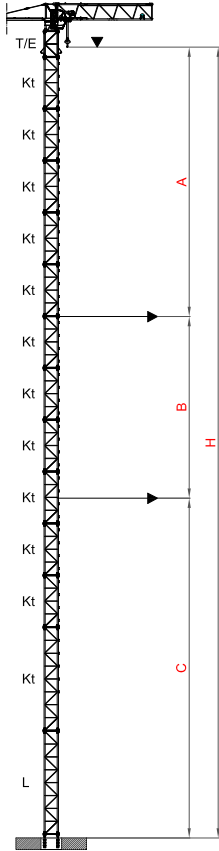

| | PAG. 4 ① MONOBLOCK K/5,9m |
|-------------------|------------------------------|
| A max. | 30,6 m |
| B max. | 17,7 m |
| C max. | 40,1 m |
| Hl max. | 52,3 m |
| H max. C+B+A | 88,4 m |
| H max. C+B+B+A | 106,1 m / (1) |

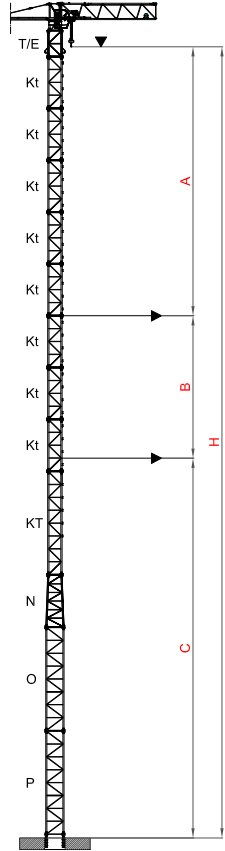

| | PAG. 4 ② MONOBLOCK K/5,9m |
|-------------------|------------------------------|
| A max. | 30,6 m |
| B max. | 17,7 m |
| C max. | 52 |
| Hl max. | 64,1 m |
| H max. C+B+A | 100,3 m |
| H max. C+B+B+A | 118 m / (1) |

(i) Consultarnos - Consultateci - Consult us - Nous consulter - Auf anfrage - Другие высоты подъема и наращивание крана по запросу

Proceso de trepado (S17) - Climbing - Kletterkrane - Telescopable - Sopralzo idraulico - Процесс наращивания крана

C25 TREPADO EXTERNO / EXTERNAL CLIMBING / GEANKERTER KRAN / GRUE ANDRÉE / GRU ANCORATA / ВОСХОЖДЕНИЕ ЭКСТЕРНО

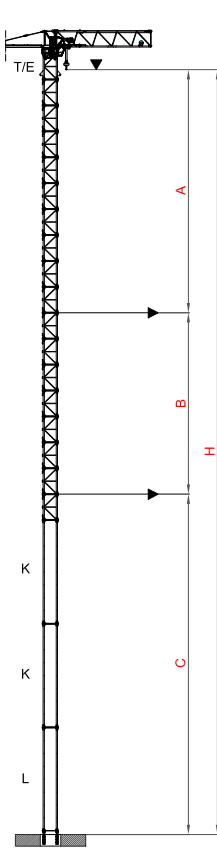

| | MONOBLOCK K/2,95m |
|---------|-------------------|
| A max. | 30,6 m |
| B max. | 20,6 m |
| C max. | 44,5 m |
| Hl max. | 52,3 m |
| H max. | 95,7 m |
| C+B+A | 116,3 m / ① |

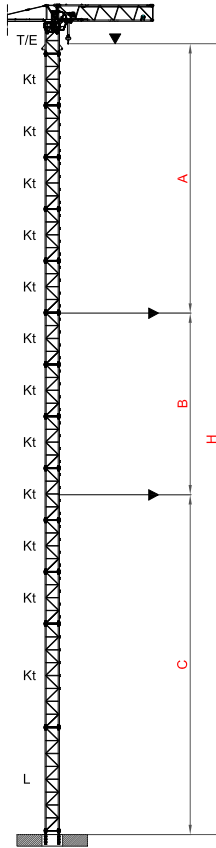

| PAG. 4 ① | MONOBLOCK K/5,9m |
|-------------|------------------|
| A max. | 30,6 m |
| B max. | 17,7 m |
| C max. | 40,1 m |
| Hl max. | 52,3 m |
| H max. | 88,4 m |
| C+B+A | 106,1 m / ① |

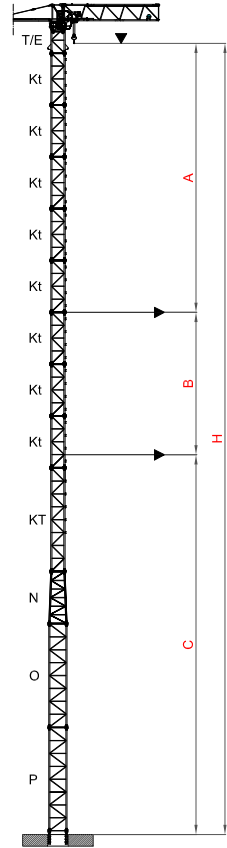

| PAG. 4 ② | MONOBLOCK K/5,9m |
|-------------|------------------|
| A max. | 30,6 m |
| B max. | 17,7 m |
| C max. | 52 |
| Hl max. | 64,1 m |
| H max. | 100,3 m |
| C+B+A | 118 m / ① |

① Consultarnos - Consultateci - Consult us - Nous consulter - Auf anfrage - Другие высоты подъема и наращивание крана по запросу

Trepado interno (S12) - Bottom climbing Climbing crane

TREPADO INTERNO (S12) / BOTTOM CLIMBING CRANE / KLETTERKRANE IM GEBÄUDE / TÉLESCOPAGE SUR DALLES / GRU CLIMBING / ВНУТРЕННИЙ ПРОЦЕСС ТЕЛЕСКОПИРОВАНИЯ

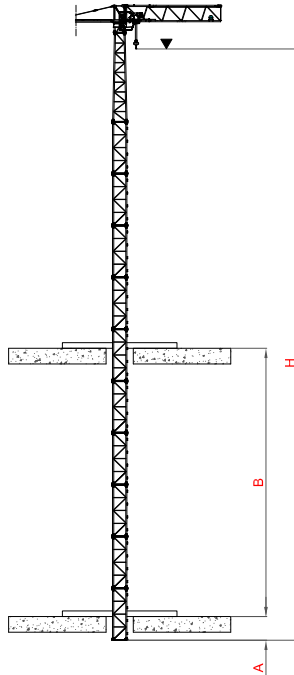

- ① Consultarnos - Consultateci - Consult us - Nous consulter - Auf anfrage -
Другие высоты подъема и наращивание крана по запросу

Trepado interno (S17) - Bottom climbing Climbing crane



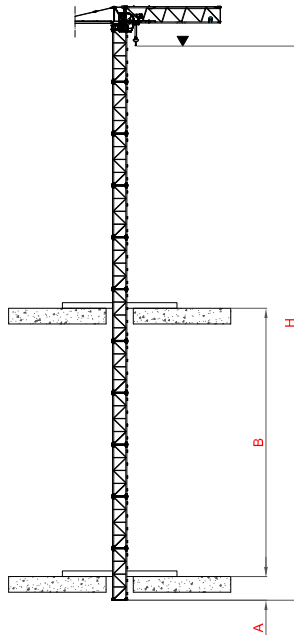

TREPADO INTERNO (S17) / BOTTOM CLIMBING CRANE / KLETTERKRANE IM GEBÄUDE / TÉLESCOPAGE SUR DALLES / GRU CLIMBING / ВНУТРЕННИЙ ПРОЦЕСС ТЕЛЕСКОПИРОВАНИЯ

TLS



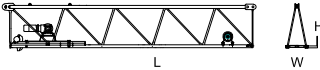
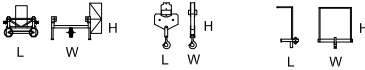
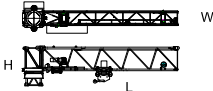

① Consultarnos - Consultatevi - Consult us - Nous consulter - Auf anfrage -
Другие высоты подъема и наращивание крана по запросу

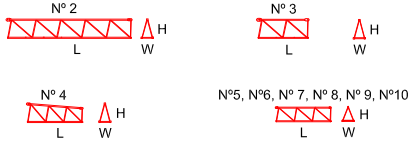

Dimensiones y transporte - dimensions and transport - Abmessungen und Transport - dimensions et des transport - dimensioni e trasporti - Размеры и транспорта

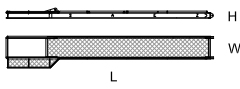
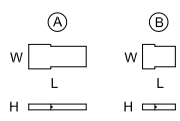
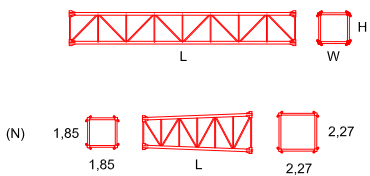
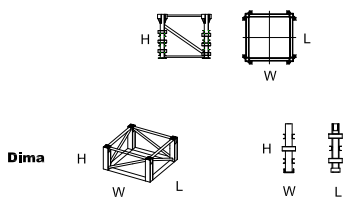
| | L(m) | W(m) | H(m) | Peso(Kg) |
|---|-------|------|------|---|
| Unidad de rotacion (S12) / Complete slewing unit / Drehbühne / Orientation / Rotazione / Оголовок башни  | 1,86 | 1,86 | 3 | 3925 |
| Balcon giro corto / short slewing balcony Balcon giro largo / long slewing balcony | | | | 117 110 |
| Unidad de rotacion (S17) / Complete slewing unit / Drehbühne / Orientation / Rotazione / Оголовок башни  | 1,86 | 1,86 | 3 | 3925 |
| Balcon giro corto / short slewing balcony Balcon giro largo / long slewing balcony | | | | 117 110 |
| Pluma tramo primero / Jib heel section / Ausleger-Anlenkstück / Pied de fleche / Settore articolato di braccio / Корневая секция стрелы  | 10,7 | 1,25 | 2,3 | 3567 |
| Equipo de Elevacion / Holst whl'nch Balcon pluma 1 / Jib 1 balcony | | | | 690 117 |
| Gancho, Carro y Puntera / Hook, Trolley and jib head / Lasthaken - Laufkatze-Cabeça de Lança / Crochet - Charlot-Pointe de fleche / Gancio - Carrello e Punta freccia / Крюк и грузовая тележка  | | | | 1,55 1,35 1,5 291 0,8 0,15 1,5 242 0,8 1,2 1,4 100 |
| Unidad de rotacion + pluma 1 / Complete slewing unit + jib heel section / Drehbühne / Orientation / Rotazione  | 11,96 | 2,3 | 3 | 8142 |
| Cablna y soporte / Cabln and platform / Kablne und wartungs / Cablne et support / Cablna e supporto / Кабина с основой  | 3,3 | 1,3 | 2,35 | 1135 |
| Elemento intermedio de pluma / Intermediate jib section / Ausleger-Zwischenstück / Element Intern. de fleche / Spezzone di braccio / Промежуточная секция стрелы  | | | | 2 10,3 1,11 1,83 1375 3 5,22 1,11 1,81 575 4 5,22 1,11 1,8/1,3 555 5 5,2 1,11 1,3 535 6 5,17 1,11 1,3 415 7 5,17 1,11 1,3 370 8 5,14 1,11 1,28 295 9 5,14 1,11 1,28 250 10 5,14 1,11 1,28 255 |

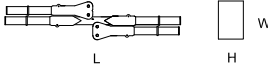
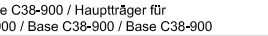
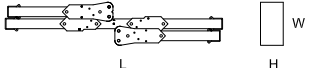
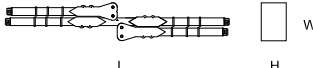
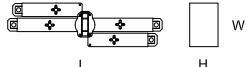
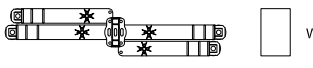
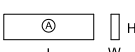
TLS

| | | L(m) | W(m) | H(m) | Peso(Kg) | |
|---|--|-----------|------|------|----------|-------|
| Contrapluma con tirantes / Counter-jib and tie-bars / Gegenaustleger / Contre-fleche / Controbraccio / Консоль противовеса | | | | | | |
|  | | 11,94 | 1,8 | 0,6 | 3352 | |
| Barandillas / Protection | | | | | 240 | |
| Bloque de contrapeso / Counterweight blocks / Gegengewichtsböcke / Bloc de contrepoids / Blocco di contrappeso / Плита противовеса | | | | | | |
|  | | A | 3,5 | 1,25 | 0,29 | 2750 |
| | | B | 1,83 | 1,25 | 0,29 | 1500 |
| Elemento de torre / Tower section / Turmstück / Élément de mât / Elemento di torre / Башенные секции | | | | | | |
|  | | J | 10 | 1,85 | 1,38 | 3520 |
| | | K | 11,8 | 1,85 | 1,85 | 4620 |
| | | K | 5,9 | 1,85 | 1,85 | 2505 |
| | | K | 3 | 1,85 | 1,85 | 1500 |
| | | L | 11,8 | 1,85 | 1,85 | 5325 |
| | | O | 11,8 | 2,27 | 2,27 | 4980 |
| | | O | 5,9 | 2,27 | 2,27 | 2680 |
| | | O | 3 | 2,27 | 2,27 | 1580 |
| | | P | 11,8 | 2,27 | 2,27 | 5880 |
| | | N | 5,9 | | | 2850 |
| | | X | 6 | 2,27 | 2,29 | 4830 |
| | | T | 6 | 2,27 | 2,29 | 4780 |
| | | T | 12 | 2,27 | 2,29 | 9000 |
| | | U | 6 | 2,31 | 2,34 | 6200 |
| | | U | 12 | 2,31 | 2,34 | 11180 |
| | | Z | 6 | 2,31 | 2,55 | 7825 |
| | | Z | 12 | 2,31 | 2,55 | 15064 |
| | | ZR | 6 | 2,31 | 2,55 | 7925 |
| | | ZR | 12 | 2,31 | 2,55 | 15200 |
| Elemento de empotre / Foundation anchor / Fundamentanker / Pleds de scellement / El anegare / Анкерные крепления | | | | | | |
|  | | S60/8 | 1,85 | 1,85 | 1,6 | 956 |
| | | S60/R16 | 1,85 | 1,85 | 1,6 | 1108 |
| | | S70/8 | 2,27 | 2,27 | 1,6 | 1122 |
| | | S70R/16 | 2,27 | 2,27 | 1,6 | 1274 |
| | | S75R16/20 | 0,35 | 0,35 | 1,6 | 1200 |
| | | S75R16/22 | 0,5 | 0,5 | 2 | 1400 |
| | | S75R16/26 | 0,5 | 0,5 | 2,4 | 2100 |
| | | S75R24/26 | 0,5 | 0,5 | 2,4 | 3400 |
| | | S75R24/30 | 0,8 | 0,8 | 3 | 3600 |
| | | S75R32/26 | 0,5 | 0,5 | 3 | 3500 |
| | | Dima | 2,31 | 2,34 | 0,8 | 1650 |

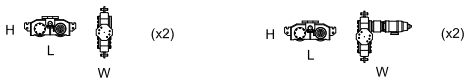
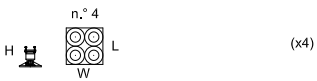
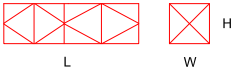
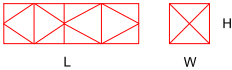
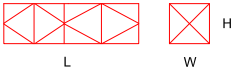
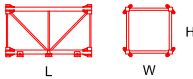
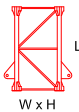
| | L(m) | W(m) | H(m) | Peso(Kg) |
|---|------------|-------------|------------|--------------|
| <p>Base C38 / base C38/ Hauptträger für fundamentkreuz C38 / Base C38 / Base C38</p>  | 5,75 | 1,47 | 0,77 | 3670 |
| <p>Base C38-900 / base C38-900 / Hauptträger für fundamentkreuz C38-900 / Base C38-900 / Base C38-900</p>  | 5,75 | 1,47 | 0,97 | 5550 |
| <p>Base Cruciforme C45-700 / Crossbase C45-700 / Fundamentkreuz C45-700 / Châssis C45-700 / Carro base C45-700</p>  | 6,7 | 1,3 | 0,77 | 6190 |
| <p>Base C60-900 / base C60-900 / Hauptträger für fundamentkreuz C60-900 / Base C60-900 / Base C60-900</p>  | 8,66 | 1,47 | 0,96 | 8625 |
| <p>Base C45R-P / base C45R-P / Hauptträger für fundamentkreuz C45R-P / Base C45R-P / Base C45R-P</p>  | 6,9 | 1,94 | 1,14 | 9000 |
| <p>Base C60R-P/U / base C60R-P/U / Hauptträger für fundamentkreuz C60R-P/U / Base C60R-P/U / Base C60R-P/U</p>  | 9,01 | 1,94 | 1,35 | 13500 |
| <p>Bloque lastre de base / Base ballast block / Grundballastblöcke / Bloc de lest de base / Blocco di zavorra alla base</p>  | 4,5 5,8 | 0,51 0,4 | 0,9 1,5 | 5000 8000 |
| <p>Bloque apoyo de base / Base support block / Grundballastblöcke / Bloc de appui de base / Blocco di appoggio alla base</p>  | 2 | 0,5 | 2 | 5000 |

| | L(m) | W(m) | H(m) | Peso(Kg) | |
|--|---------------|------|------|----------|------|
| Traslacion / Travelling bogies / Kranfahren / Traslation / Traslazione  | 1,15 | 0,25 | 0,45 | 450 | |
| | 1,15 | 1,25 | 0,45 | 505 | |
| Niveladores / Levellers / Spindel pyramide / Niveleurs / Piedi regolabile  | 1,20 | 1,20 | 0,65 | 250 | |
| Jaula de telescopaje tipo K / Cllmblng cage type K / Hydraulkbühne K / Cage de telescopage type K / Gabbia di montaggio K / Монтажная обойма K  | K-2,95 | 7,35 | 2,1 | 2,1 | 6400 |
| | K-5,9 | 11,2 | 2,1 | 2,1 | 8000 |
| Completa / Full / Vollständigge / Complete / completa / полный  | K-2,95 | | | | 4890 |
| | K-5,9 | | | | 6490 |
| Estructura / Steel frame / Struktur / Construction / Struttura / структура  | K-2,95 | | | | 1510 |
| | K-5,9 | | | | 1510 |
| Tramo trepador Kt / Tower section Kt / Turmstück Kt / Élément de mât Kt / Elemento di torre Kt / Башенные секции Kt  | Kt | 2,95 | 1,85 | 1,85 | 1475 |
| | Kt | 5,9 | 1,85 | 1,85 | 2572 |
| | Kt | 11,8 | 1,85 | 1,85 | 4750 |
| Tramo enlace caja 1,7 / Tower section 1,7 / Turmstück 1,7 / Élément de mât 1,7 / Elemento di torre 1,7 / Башенные секции 1,7  | | 2,95 | 2,3 | 2,3 | 1590 |
| Marco trepado externo K / Tie-frame / Cadre d'encrage externe / Sopralzo con ancoraggio esterno / внешняя рамка пристежки  | K | 2,31 | 2,31 | 0,26 | 950 |



40" HC x 5 - HBG 23 m + C45
+1xK11.8+1xJ
40" HC x 6 - HBG 23 m + C45
+2xK11.8



x 4 - HBG 23 m + C45
+1xK11.8+1xJ
x 5 - HBG 23 m + C45
+2xK11.8