

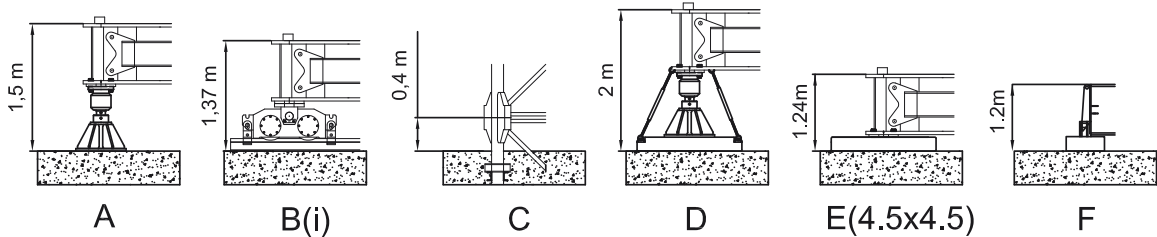

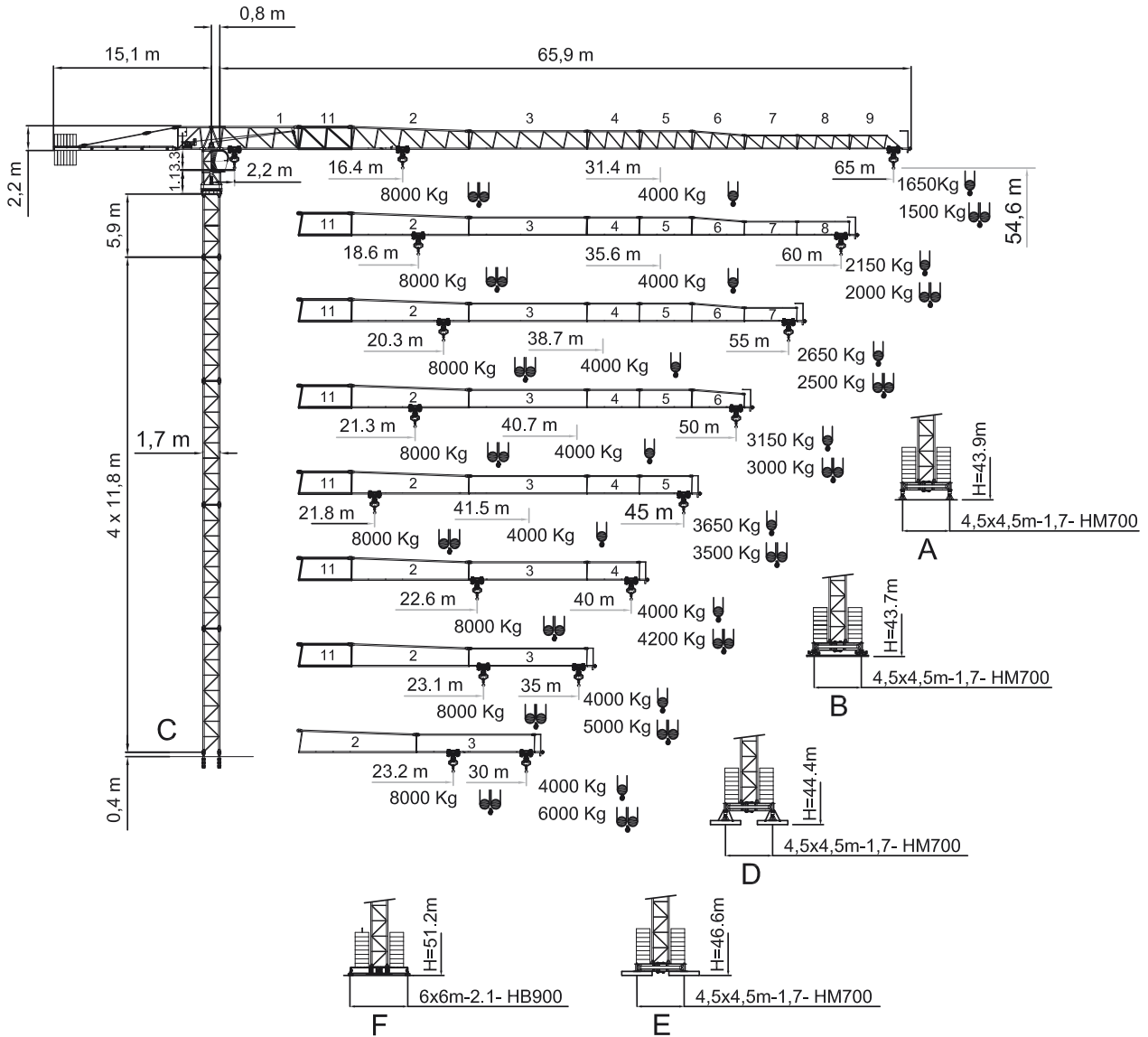

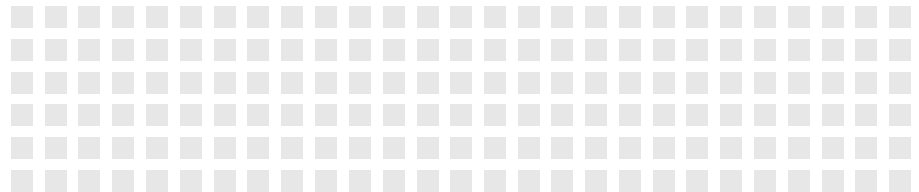



































TLS 65 8T





Curvas de cargas- Load diagrams- Lastkurven- Courbes de charges- Curve di carico

65 m		10	15	20	25	30	31,45	35	40	45	50	55	60	65	m	
		4000	4000	4000	4000	4000	4000	3530	3020	2620	2300	2040	1830	1650	Kg	
		10	15	18	20	25	30	35	40	45	50	55	60	65	m	
		4000	4000	4000	4000	4000	4000	3330	2830	2440	2130	1880	1680	1500	Kg	
60 m		10	15	20	25	30	35	35,6	40	45	50	55	60	m		
		4000	4000	4000	4000	4000	4000	4000	3500	3050	2690	2390	2150	Kg		
		10	15	20	25	30	34,2	35	40	45	50	55	60	m		
		4000	4000	4000	4000	4000	4000	3890	3320	2880	2520	2240	2000	Kg		
55 m		10	15	20	25	30	35	38,7	40	45	50	55	m			
		4000	4000	4000	4000	4000	4000	4000	3860	3360	2970	2650	Kg			
		10	15	20	25	30	35	37,3	40	45	50	55	m			
		4000	4000	4000	4000	4000	4000	4000	3680	3200	2810	2500	Kg			
50 m		10	15	20	25	30	35	40	40,7	45	50	m				
		4000	4000	4000	4000	4000	4000	4000	4000	3560	3150	Kg				
		10	15	20	25	30	35	39,3	40	45	50	m				
		4000	4000	4000	4000	4000	4000	4000	3920	3410	3000	Kg				
45 m		10	15	20	25	30	35	40	40,7	45	50	m				
		4000	4000	4000	4000	4000	4000	4000	4000	3560	3150	Kg				
		10	15	20	25	30	35	40	40,1	45	50	m				
		4000	4000	4000	4000	4000	4000	4000	4000	3500	Kg					
40 m		10	15	20	25	30	35	40	40,7	45	50	m				
		4000	4000	4000	4000	4000	4000	4000	4000	3560	3150	Kg				
		10	15	20	22	25	30	35	40	40	45	m				
		4000	4000	4000	4000	4000	4000	4000	4000	4000	3500	Kg				
35 m		10	15	20	25	30	35	40	40,7	45	50	m				
		4000	4000	4000	4000	4000	4000	4000	4000	3560	3150	Kg				
		10	15	20	22	25	30	35	40	40	45	m				
		4000	4000	4000	4000	4000	4000	4000	4000	4000	3500	Kg				
30 m		10	15	20	25	30	35	40	40,7	45	50	m				
		4000	4000	4000	4000	4000	4000	4000	4000	3560	3150	Kg				
		10	15	20	22	25	30	35	40	40	45	m				
		4000	4000	4000	4000	4000	4000	4000	4000	4000	3500	Kg				

TLS 65 8T

Mecanismos- Mechanisms- Antriebe- Mécanismes- Meccanismi

45 Hp (33Kw) - INV-5V
 H.B.G 126Mts S/R Ø12
 H.B.G LEBUS 320Mts S/R Ø12

▲ ▼	350 m LEBUS 734 m	m/min Kg Kw	0-6.3	0-42	0-56	0-76.4	0-104	0-15	0-21	0-28	0-38	0-52
			4000	4000	3000	2000	1250	8000	8000	6000	4000	2500
			33	33	33	33	33	33	33	33	33	33

◀ ▶	m/min	11 / 37 / 75			11 / 37 / 75		
	Kw	3,0			3,0		
⊙	r.p.m	0,3	0,6	0,9	0,3	0,6	0,9
	Nm	2 x 65			2 x 65		
⏏	m/min	12 / 24			12 / 24		
	Kw	4 x 3			4 x 3		

* Opcional / Optional / Opzionale /

- ⬆ Elevación / Hoisting / Heben / Levage / Sollevamento
- ⏏ Distribución / Trolleying / Katzfahren / Distribution / Distribuzione
- ⊙ Orientación / Slewing / Schwenken / Orientation / Rotazione
- ⏏ Traslacion / Travelling / Schienenfahren / Translation / Traslazione
- 🔗 Cable / Rope / Seil / Câble / Fune

2000/14/CEE 2005/88/CEE	2006/95 /CEE	400 V 50 Hz	100m 4x35mm ²	GENERADOR 300 kVA	POTENCIA INSTALADA 60 KW
----------------------------	-----------------	----------------	-----------------------------	----------------------	--------------------------------

2000/14/CEE 2005/88/CEE	2006/95 /CEE	380 V 60 Hz	100m 4x35mm ²	OPCIONAL
----------------------------	-----------------	----------------	-----------------------------	----------

Bloque de contrapeso- Counterweight blocks- Gegengewichtsblöcke-
 Bloc de contrepoid- Blocco di contrappeso

⏏	65 m			60 m			55 m			50 m		
	A	B	C	A	B	C	A	B	C	A	B	C
	8	-	-	8	-	-	7	1	-	6	2	-
	20000 Kg			20000 Kg			19000 Kg			18000 Kg		

⏏	45 m			40 m			35 m			30 m		
	A	B	C	A	B	C	A	B	C	A	B	C
	6	1	-	6	-	-	4	2	-	3	2	-
	16500 Kg			15000 Kg			13000 Kg			10500 Kg		

Proceso de trepado- External climbing- Kletterkrane- Telescopable- Sopralzo idraulico

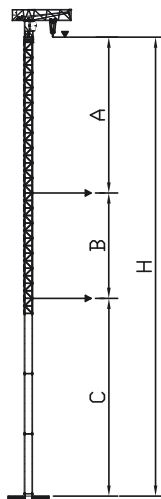

	S17-8/8
	MTS
A max.	30
B max.	20.7
C max.	48
H max.	①

FEM 1005-C25 / EN 14439- Mástil / Reacciones- Masts / Reactions- Mast / Eckdrücke- Mat / Réactions- Torre / Réazioni

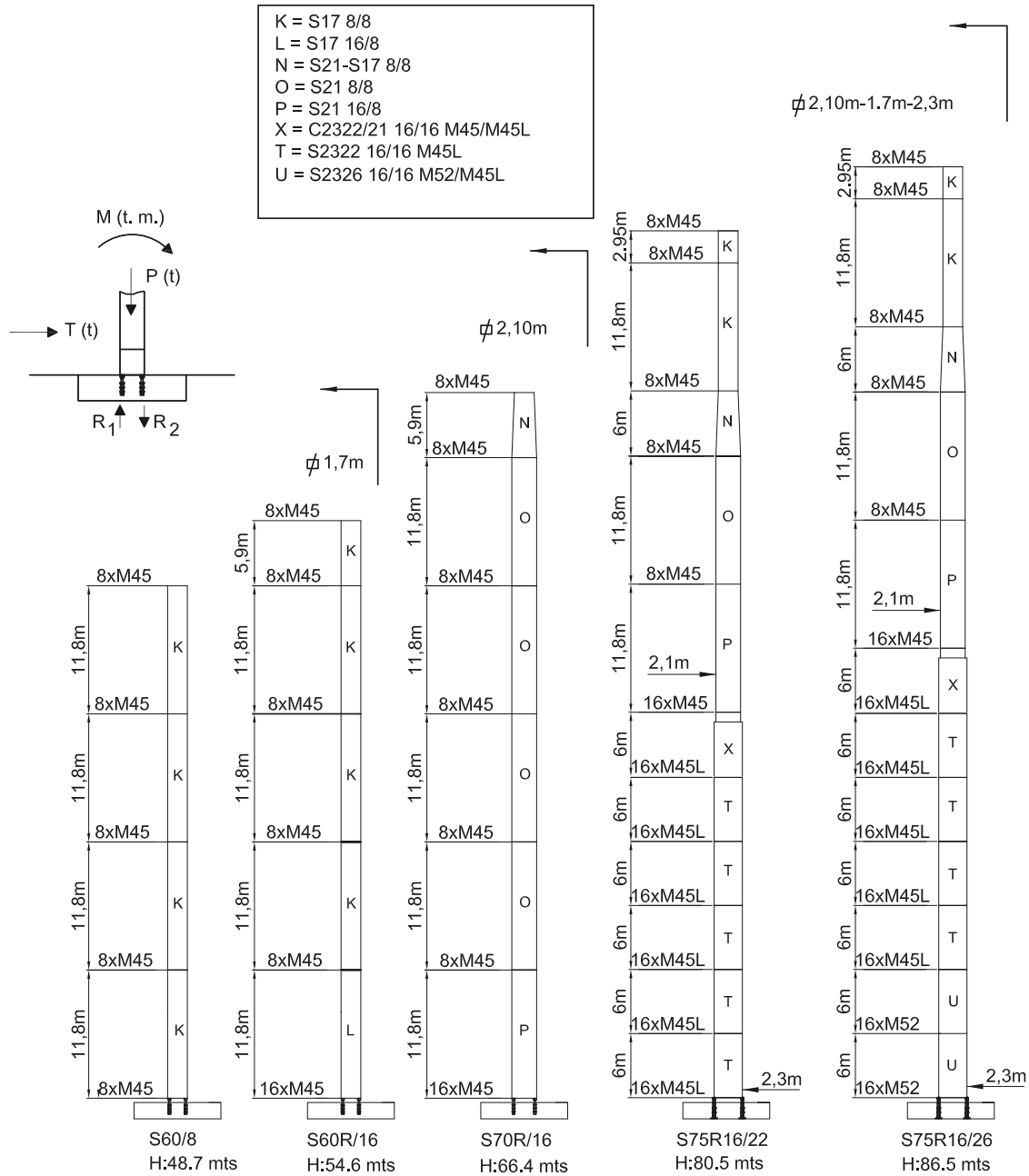

H (m)	25,1	31	36,9	42,8	48,7	51,7	54,6
M (T-m)	232,4	281,3	352	419,6	518,3	564,5	615,2
T (t)	6,2	7,4	8,8	9,7	11,2	11,6	12,3
P (t)	45,3	51,4	53,5	55,6	57,7	58,9	62,8
R ₁ (t)	98,2	119,7	152,5	184	223	251,3	274,2
R ₂ (t)	-120,8	-145,4	-179,2	-211,7	-258,7	-280,8	-305,7

H (m)	86,5	80,5	74,5	66,4	63,5	60,5	57,6
M (T-m)	1387,6	1180	970,2	764,2	708,9	657,6	611,2
T (t)	27,6	24,6	22	17,5	17	16,4	15,8
P (t)	102,7	94	89,4	85,5	83,9	82,6	81,4
R ₁ (t)	453	383,6	312,3	258,2	238,6	221,3	204,5
R ₂ (t)	-504,3	-430,7	-350	-296	-275,5	-256,5	-238,7

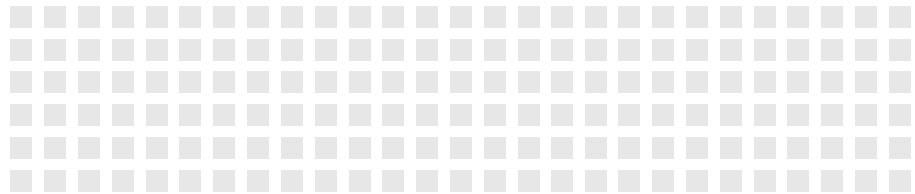

TLS 65 8T

FEM 1005-C25 / EN 14439- Bloque lastre de base- Base ballast block- Grundballastblöcke - Bloc de lest de base- Blocco di zavorra alla base

(A)

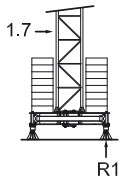

	H (m)	20,3 m	23,3 m	26,2 m	29,2 m	32,1 m	35,1 m	38 m	41 m	43,9 m
	R1 (t)	73,6 t	74,4 t	75,6 t	78,8 t	80 t	81,3 t	82,4 t	86,7 t	103 t
4,5 x 4,5 m-1,7- HM 700	Z (t)	83,6 t	83,6 t	83,6 t	91,2 t	91,2 t	91,2 t	91,2 t	106,4 t	106,4t

(B)

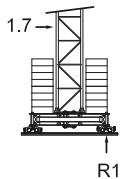

	H (m)	20,1 m	23,1 m	26 m	29 m	31,9 m	34,9 m	37,8 m	40,8 m	43,7 m
	R1 (t)	73,6 t	74,4 t	75,6 t	78,8 t	80 t	81,3 t	82,4 t	86,7 t	103 t
4,5 x 4,5 m-1,7- HM 700	Z (t)	83,6 t	83,6 t	83,6 t	91,2 t	91,2 t	91,2 t	91,2 t	106,4 t	106,4t

(D)

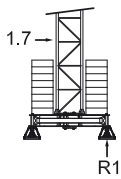

	H (m)	20,8 m	23,8 m	26,7 m	29,7 m	32,6 m	35,6 m	38,5 m	41,5 m	44,4 m
	R1 (t)	73,6 t	74,4 t	75,6 t	78,8 t	80 t	81,3 t	82,4 t	86,7 t	103 t
4,5 x 4,5 m-1,7- HM 700	Z (t)	83,6 t	83,6 t	83,6 t	91,2 t	91,2 t	91,2 t	91,2 t	106,4 t	106,4t

(E)

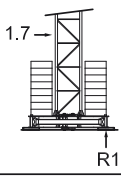

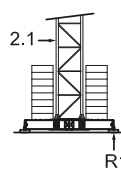

	H (m)	20 m	23 m	25.9 m	28.9 m	31.8 m	34.8 m	37.7 m	40.7 m	43,6 m	
	R1 (t)	73,6 t	74,4 t	75,6 t	78,8 t	80 t	81,3 t	82,4 t	86,7 t	103 t	
4,5 x 4,5 m-1,7- HM 700	Z (t)	83,6 t	83,6 t	83,6 t	91,2 t	91,2 t	91,2 t	91,2 t	106,4 t	106,4t	
	H (m)	46,6 m									
	R1 (t)	125 t									
	Z (t)	121,6 t									

(F)

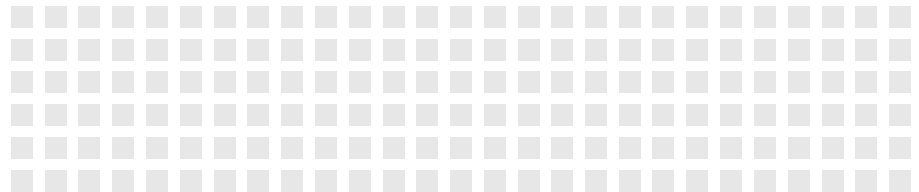

	H (m)	18.8 m	24.7 m	30.6 m	36.5 m	42.4 m	48.3 m	51.2 m		
	R1 (t)	44 t	46.1 t	52 t	59.8 t	77.7 t	104 t	115.8 t		
6 x 6 m-2,1/1,7- HB 900	Z (t)	45.6 t	45.6 t	45.6 t	60.5 t	68.4 t	91.2 t	98.8 t		

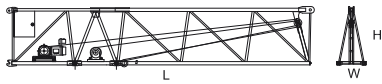
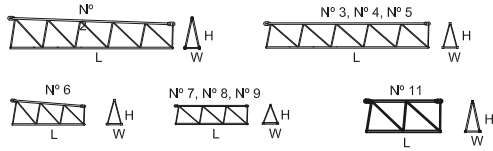
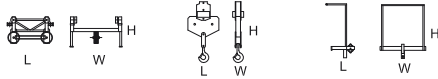

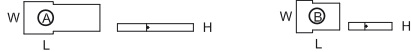
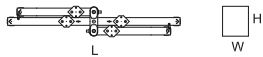
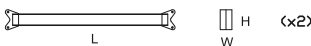
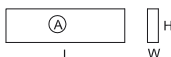

	L(m)	W(m)	H(m)	Peso(Kg)	
Pluma tramo primero / Jib heel section / Ausleger-Anlenkstück / Pied de fleche / Settore articolato di braccio 	11.9	1.25	2.3	5800	
Elemento Intermedio de pluma / Intermediate jib section / Ausleger-Zwischenstück Élément interm. de fleche / Spezzone di braccio 	2 3 4 5 6 7 8 9 11	11.6 11.6 5.3 5.3 5.3 5.3 5.3 5.15 5.15	1.13 1.13 1.13 1.13 1.13 1.13 1.13 1.13 1.13	2.25 1.8 1.8 1.8 1.8 1.45 1.45 1.4 2.25	2194 1720 620 530 470 376 326 248 1280
Gancho, Carro y Puntera / Hook, Trolley and jib head / Lasthaken - Laufkatze-Cabeça de Lança Crochet - Chariot-Pointe de fleche / Gancio - Carrello e Punta freccia 	1.2 0.8 0.8	1.35 0.15 1.2	0.8 1.5 1.4	290 330 108	
Contrapluma / Counter-jib / Gegenausleger / Contre-fleche / Controbraccio 	11.94	1.8	0.6	2575	
Bloque de contrapeso / Counterweight blocks / Gegengewichtsblöcke / Bloc de contrepoids / Blocco di contrappeso 	3.2 1.83	1.25 1.25	0.29 0.29	2500 1500	
Base Cruciforme 4,5 X4,5 / Crossbase 4,5 X 4,5 / Fundamentkreuz 4,5 X 4,5 / Châsis 4,5 X 4,5 / Carro base 4,5 X 4,5 	6.7	1.1	1.2	5750	
Vigas auxil. de base / Half base beams / Halbträger für fundamentkreuz / Semipoutre de châsis de base / Travi di congiunzi di congiunzione 	4.4	0.3	0.55	220	
Bloque lastre de base / Base ballast block / Grundballastblöcke / Bloc de lest de base Blocco di zavorra alla base 	440	0.3	1.2	3800	

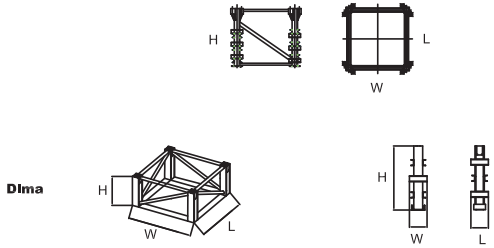
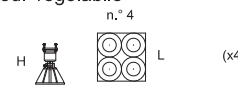
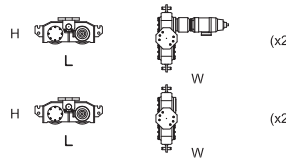
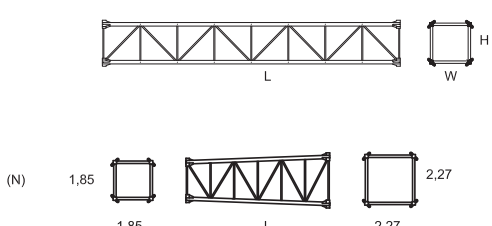
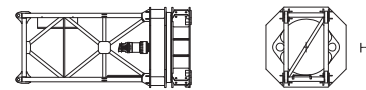
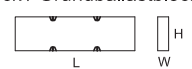
TLS 65 8T

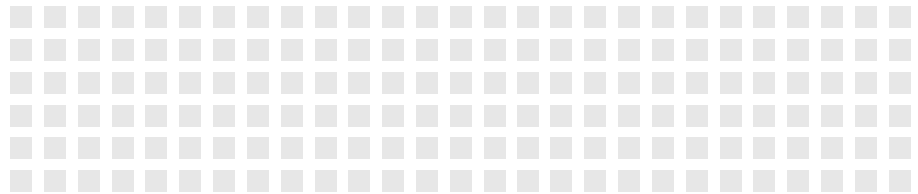
		L(m)	W(m)	H(m)	Peso(Kg)	
Elemento de empotre / Foundation anchor / Fundamentanker / Pieds de scellement El annegare 	S60/8	1,85	1,85	1,6	956	
	S60/R16	1,85	1,85	1,6	1108	
	S70/8	2,27	2,27	1,6	1122	
	S70R/16	2,27	2,27	1,6	1274	
	S75R16/20 0.35	0,35	1,6	1200		
	S75R16/22 0.5	0,5	2	2840		
	S75R16/26 0.5	0,5	2,4	3160		
	S75R24/26 0.5	0,5	2,4	3400		
	Dima	2,31	2,34	0,8	1650	
	Niveladores / Levellers / Spindel pyramide / Niveleurs / Piedi regolabile 		1,20	1,20	0,90	250
Traslacion / Travelling bogies / Kranfahren / Traslation / Traslazione 			1,15	1,25	0,45	505
			1,15	0,25	0,45	450
Elemento de torre / Tower section / Turmstück / Élément de mât / Elemento di torre 	K	11,8	1,85	1,85	4600	
	K	5,9	1,85	1,85	2472	
	K	3	1,85	1,85	1425	
	L	11,8	1,85	1,85	5520	
	O	11,8	2,27	2,27	5044	
	O	5,9	2,27	2,27	2640	
	O	3	2,27	2,27	1545	
	P	11,8	2,27	2,27	5700	
	N	5,9			3500	
	X	6	2,27	2,29	4000	
	T	6	2,27	2,29	4300	
	U	6	2,31	2,34	5910	
	Z	6	2,61	2,34	5980	
Unidad de rotacion / Complete slewing unit / Drehbühne / Partie tournante / Unitá di rotazione 		4,40	2,00	2,00	6600	
Bloque apoyo de base / Base support block / Grundballastblöcke / Bloc de appui de base Blocco di appoggio alla base 		3,75	0,5	1,2	5400	

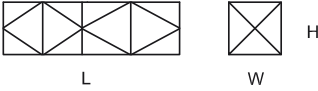
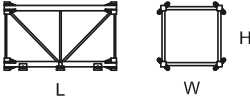

	L(m)	W(m)	H(m)	Peso(Kg)
Cabina y soporte / Cabin and platform / Kabine und wartungs / Cabine et support / Cabina e supporto 	3,00	1,15	2,35	558
Viga principal base 6x6 / Main base beam / Hauptträger für fundamentkreuz Poutre de châssis de base / Trave principale della base 	8,65	0,78	0,92	4300
Semiviga secundaria base 6x6 / Half base beam / Halbträger für fundamentkreuz Semipoutre de châssis de base / Semitrave secundaria della base 	4,27	0,68	0,97	2025
Jaula de telescopaje tipo K / Climbing cage type K / Hydraulikbühne Cage de telescopage type K / Gabbia di montaggio K 	7,35	2,1	2,1	6400
Tramo trepador / Tower element / Turmstück Élément de mât / Elemento di torre monolitico 	3	1,85	1,85	1425

DECLINAMOS TODA RESPONSABILIDAD DERIVADA DE LA INFORMACION PROPORCIONADA.
 This information is supplied without liability.
 Sämtliche Angaben erfolgen ohne Gewähr.
 Ces renseignements sont sans garantie.
 Le indicazioni contenute si intendono salvo errori ed omissioni.

ESPECIFICACIONES SUJETAS A MODIFICACIONES SIN PREVIO AVISO.
 Specifications subject to modification without notice.
 Obiges kann ohne berstaendigung geaendert werden.
 Specificazioni suscettibili de modification sans avis préalable.
 Specifiche suscettibili di variazioni senza preavviso.